

Alphard Square LED Bulkhead INSTALLATION INSTRUCTIONS



PLEASE READ THESE INSTRUCTIONS CAREFULLY BEFORE INSTALLATION AND LEAVE
A COPY WITH THE END USER FOR FUTURE REFERENCE.

SAFETY INFORMATION – We recommend that luminaires be installed by a fully qualified and competent electrician who understands building regulations and the current IEE wiring regulations. The light source contained in this luminaire shall only be replaced by the manufacturer or a qualified professional.

Before commencing any installation or maintenance work, ensure that the electricity is switched off at the mains.



IMPORTANT USER INFORMATION

Please install and use strictly in accordance with these instructions. Make sure that you have all the tools and equipment to complete the installation safely and correctly. Improper installation could cause harm to your property and/or person and void your warranty.

It is the installer's responsibility to consider fire and safety risks and take appropriate precautions.

INSTALLATION/MAINTENANCE INSTRUCTIONS & GUIDELINES

- The installation wiring must be at least 3x0.75mm and wired in accordance with the latest IEE electrical regulations or the national requirements.
- The luminaire must be installed on a ceiling or wall firm enough to hold the weight of more than five times of the fitting itself.
- Do not touch the electronic circuit and its components.
- Do not touch LEDs while installing or maintaining. The LED light source cannot be replaced.
- The luminaire must not be installed above hot objects such as ovens to avoid damage to the fitting.
- Ensure that ALL electrical connections are tight with no loose strands.
- Don't use chemicals to clean the fixture.

SPECIFICATION & DIMENSIONS

Part Code: R181301
Wattage: 24W
Power Supply: AC220-240V
Power Factor: >0.95
CCT: 4000K
CRI: >83Ra
Driver: built-in
Body: cast aluminium

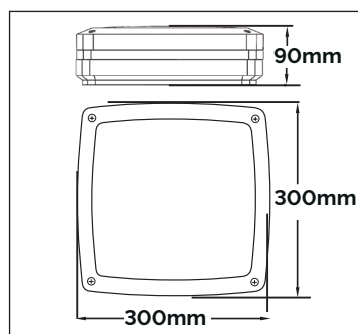

ACCESSORIES

Quantity	Name
4	Screws
4	Rawl Plug
4	Washer

Alphard Square LED Bulkhead

INSTALLATION STEPS

Before following these steps please ensure you have read and adhered to the guidelines and information overleaf.

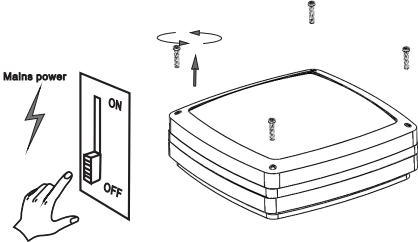
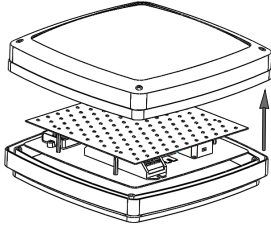
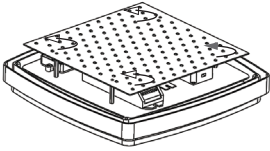
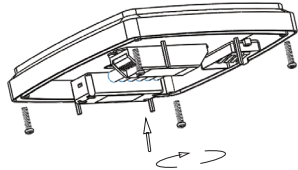
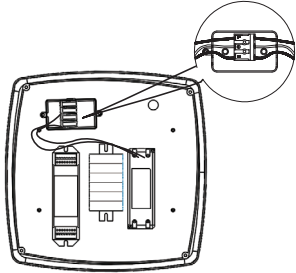
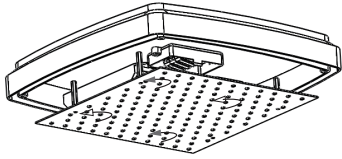
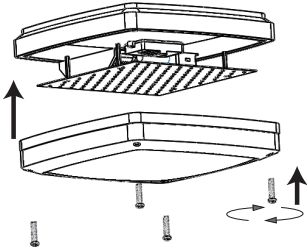
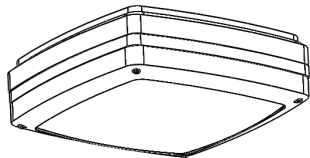
<p>STEP 1</p> <p>Turn off the power supply. Remove the screws from the front of the luminaire.</p> 	<p>STEP 2</p> <p>Remove the cover.</p> 
<p>STEP 3</p> <p>Unlock the PCB screws and remove the board.</p> 	<p>STEP 4</p> <p>Fix the base of the luminaire to the surface using rawl plug No2 and screws No1.</p> 
<p>STEP 5</p> <p>Connect the wires.</p> 	<p>STEP 6</p> <p>Lock the PCB screws back in place.</p> 
<p>STEP 7</p> <p>Secure the cover to the base by tightening the screws.</p> 	<p>STEP 8</p> <p>Installation complete.</p> 



ENVIRONMENTAL PROTECTION

Waste Electrical & Electronic Equipment Regulations (WEEE) requires that any of our products showing this marking must not be disposed of with other household or commercial waste. To prevent possible harm to the environment or human health from uncontrolled waste disposal, please separate any such product from other waste types and recycle it responsibly at your local facilities. Check with your Local Authority, Recycling Centre or retailer for recycling advice.

WARRANTY

This product is in warranty in the UK for a period of 5 year from the date of purchase. The guarantee is invalid in the case of improper use, installation, tampering, removal of the Q.C. date label, installation in an improper working environment or installation not according to the current edition of the IEE Wiring Regulations. Should this product fail during the warranty period, it will be replaced free of charge, subject to the aforementioned conditions and return of the faulty unit. We do not accept responsibility for any installation costs associated with the replacement of this product. Your statutory rights are not affected.