

Aeroline Product Datasheet

Unobtrusive mini light lines

Product Data

Warranty	3 years
Applications	Interior
Certification(s)	UKCA, CE, RoHS

Physical Data

Colour Finish	White
Luminaire Fixing	Surface mounted
Construction Material	Aluminium
Diffuser Type	TPa rated

Electrical Data

Voltage Range	D24V
Power Factor	>0.50
Inrush Current	<60A
Protection Class IEC	Class III

Performance Data

Efficacy	~62-82Lm/W
Operating Temperature	-20°C to +45°C
Dimming	Dimmable driver as standard
Beam Angle	40°
Operating Hours	>30000
CRI	>80Ra
IP Rating	IP20
IK Rating	IK08
Macadam Ellipse	≤4 sdc _m
L70 B50	70,000 hours
L80 B50	50,000 hours
L90 B50	25,000 hours

Designed to fit almost everywhere



Part Codes

	Wattage	°Kelvin	Lumens	Length (mm)	Unit Weight (kg)	Running Current
R240101	2.5W	3000K	195	150	0.03	0.10A
R240102	2.5W	6000K	205	150	0.03	0.10A
R240201	5W	3000K	335	300	0.06	0.20A
R240202	5W	6000K	355	300	0.06	0.20A
R240301	9W	3000K	554	600	0.11	0.36A
R240302	9W	6000K	594	600	0.11	0.36A
R240401	14W	3000K	813	900	0.17	0.58A
R240402	14W	6000K	913	900	0.17	0.58A
R240501	15W	3000K	828	1000	0.18	0.63A
R240502	15W	6000K	958	1000	0.18	0.63A
R240601	16W	3000K	927	1200	0.22	0.67A
R240602	16W	6000K	987	1200	0.22	0.67A

Dimensions (mm)



Aeroline Family

Light Distribution:

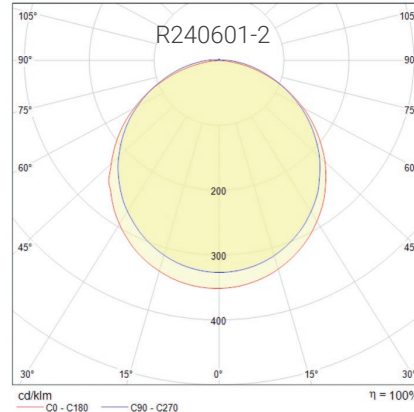
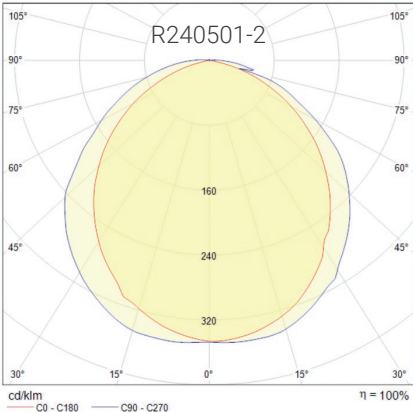
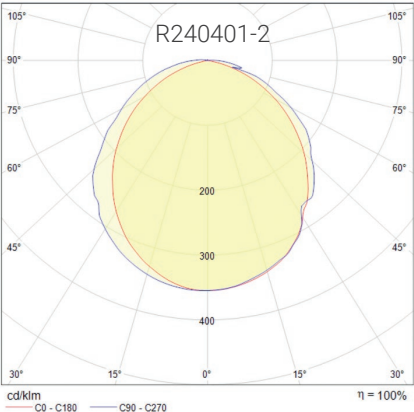
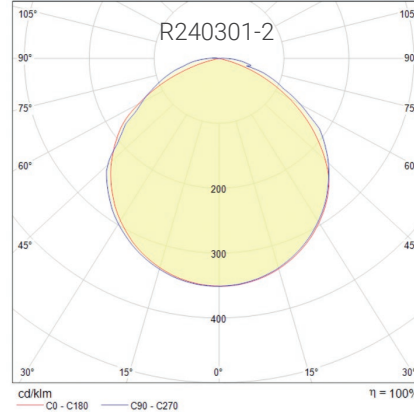
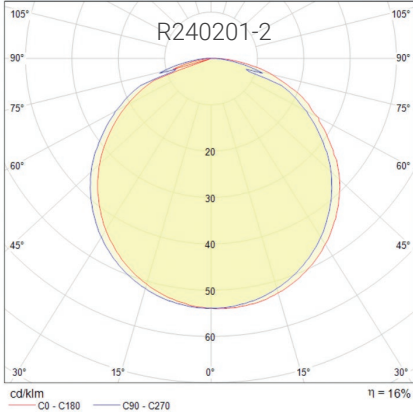
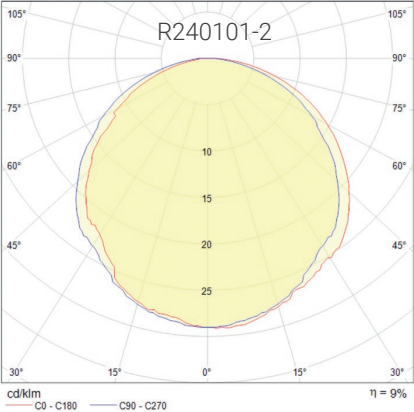

Aeroline add on items & drivers

Part code Option

R24-01	Fixing clip with screws, for 90° installation
R24-02	Fixing clip with screws, for 180° installation
R24-03	Middle connector
R24-04	Left 'L' corner connector
R24-05	'T' corner connector
R24-06	'+' corner connector
R24-07	Right 'L' corner connector
R24-08	Solid 'L' corner connector
R24-09	Input power line
R24-10	1m extension cable
R24-11	Hand by hand connector
R24-12	1 v 4 adaptor junction cable
R24-13	Touch switch
R24-14	Sensor switch
R24-15	Dimmer switch
R24-16	End cap
R24-17	Magnet, metal plate and 3M tape
R24-18	Side power entry point



Part code Option IP Rating

D-AFS-E30	Aeroline Driver 30W	IP20 with enclosed housing
D-AFS-E75	Aeroline Driver 75W	
D-AFS-E120	Aeroline Driver 120W	



Building your Aeroline system:

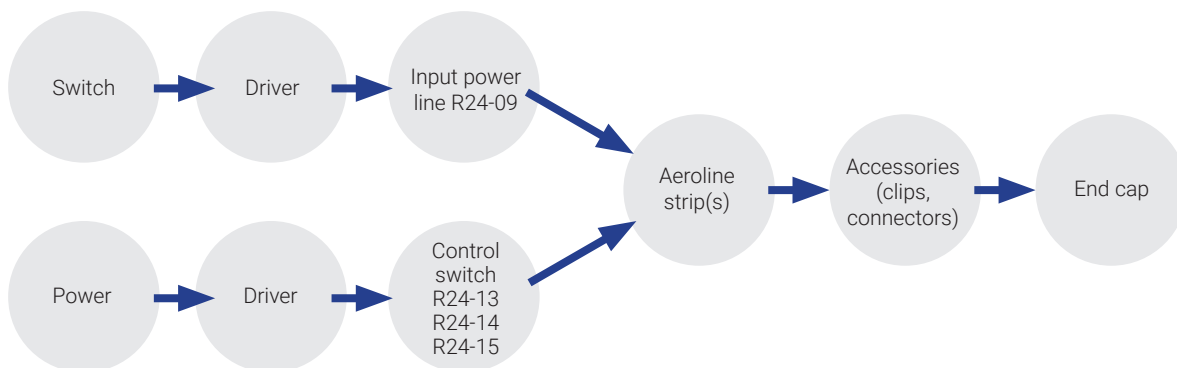

Notes:

Driver always comes with black lead that connects it to either the power line or control switch
End caps (R24-16) come as standard with each Aeroline strip. They only need to be purchased to replace lost ones